

LEVEL UP

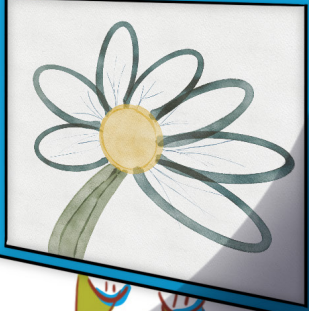
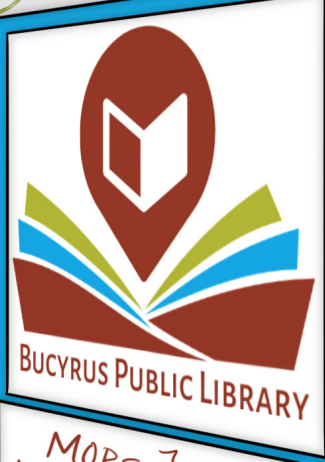
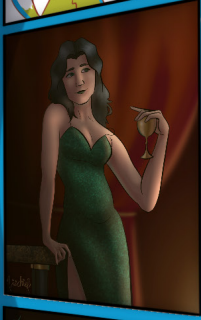
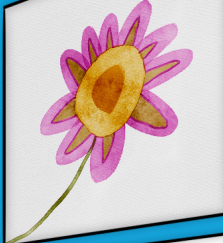

Olivier

2024 ART ZINE LEVEL UP PROGRAM

LEVEL UP

LEVEL UP is the Bucyrus Public Library's career-readiness program, which aims to encourage young adults in grades 6-12 to explore and prepare for future careers, their entry into the workforce, and/or college.

By participating in activities and using equipment and technology used by professionals in STEAM (Science, Technology, Engineering, Arts, and Mathematics) careers, participants build the relevant skills, experience, and expertise needed to help prepare them for the future careers of their choice.

The program was developed in collaboration between the Bucyrus Public Library and Mid-Ohio Educational Service Center and was expanded through the generous support of the Ohio Afterschool Network's Moonshot Ohio program and the Friends of Bucyrus Public Library.

LEVEL UP takes place at the Bucyrus Public Library Monday-Friday, 3:30-6. Young adults in grades 6-12 are welcome and encouraged to join!

The works included in this book represent only a small fraction of the amazing pieces of art and projects completed by participants during this school year. Clearly, Crawford County has a lot of talented young adults!



Artist Spotlight

Gavin C. • Wynford Middle School



Gavin C. is a 7th-grade student from Wynford Middle School. He loves art, modeling and sculpting, and creating 3-D designs.

His favorite part of LEVEL UP is learning about Blender and learning tips to improve his art in Procreate.

In the future, he would like to become a digital designer, creating 3-D models and art.

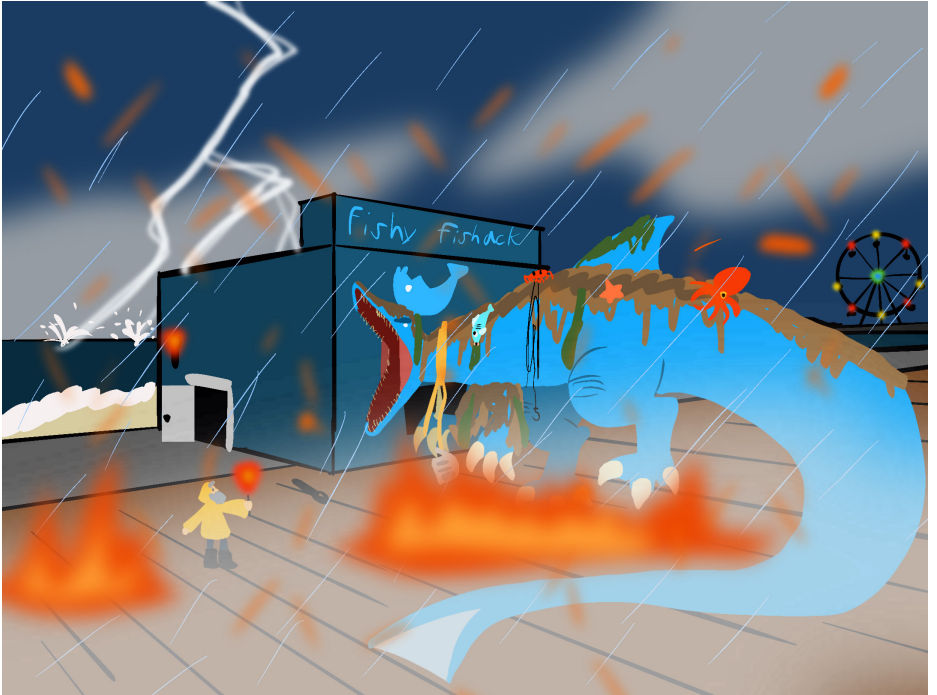

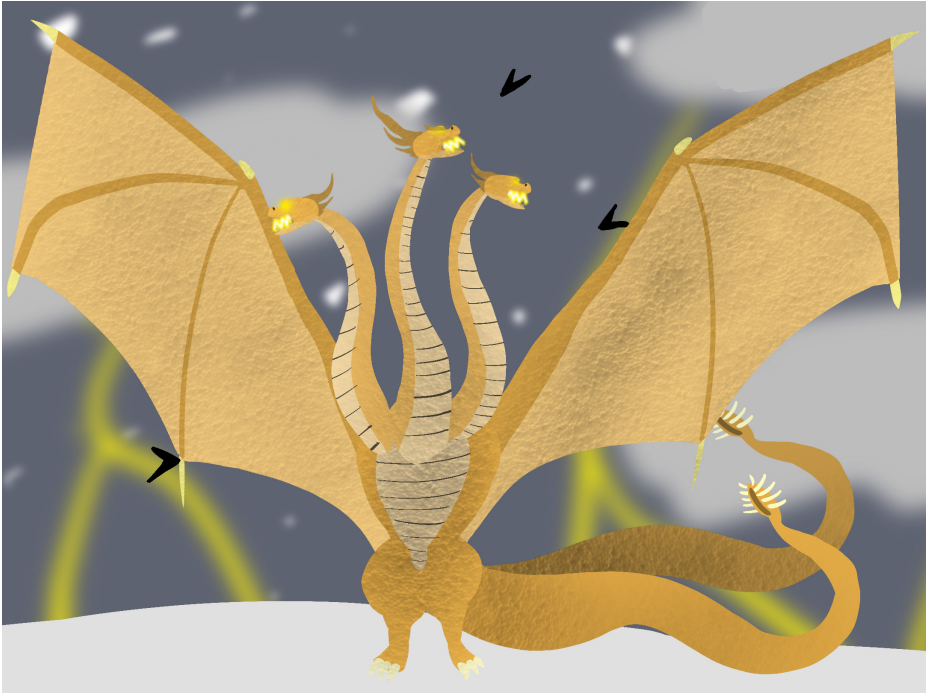

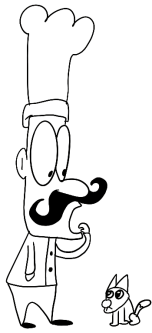

No I'm not falling more of
your tricks your not
getting another slice

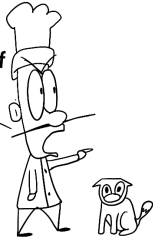

C'mon man just
one more



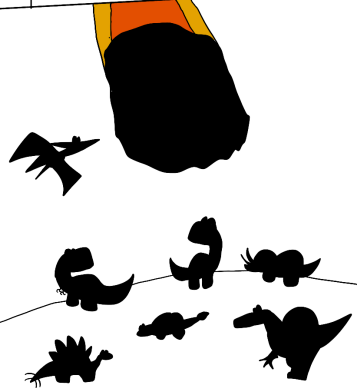
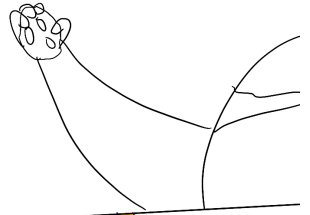
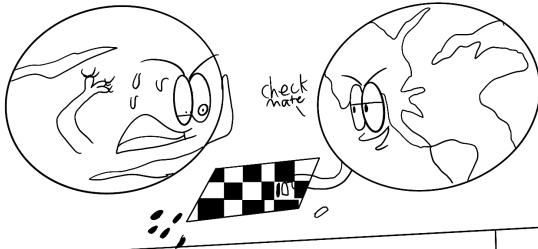

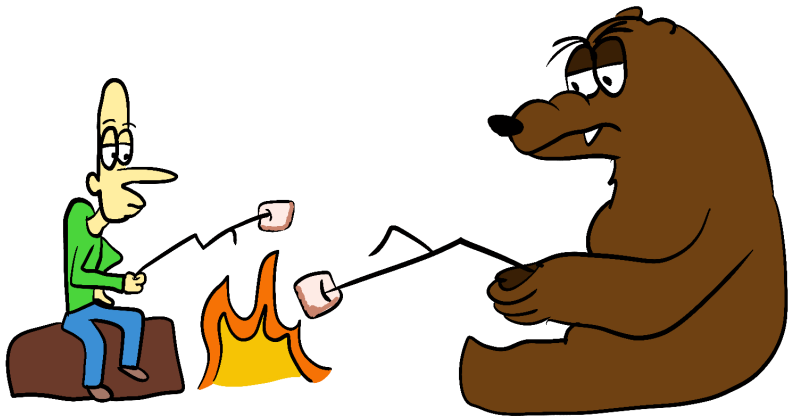

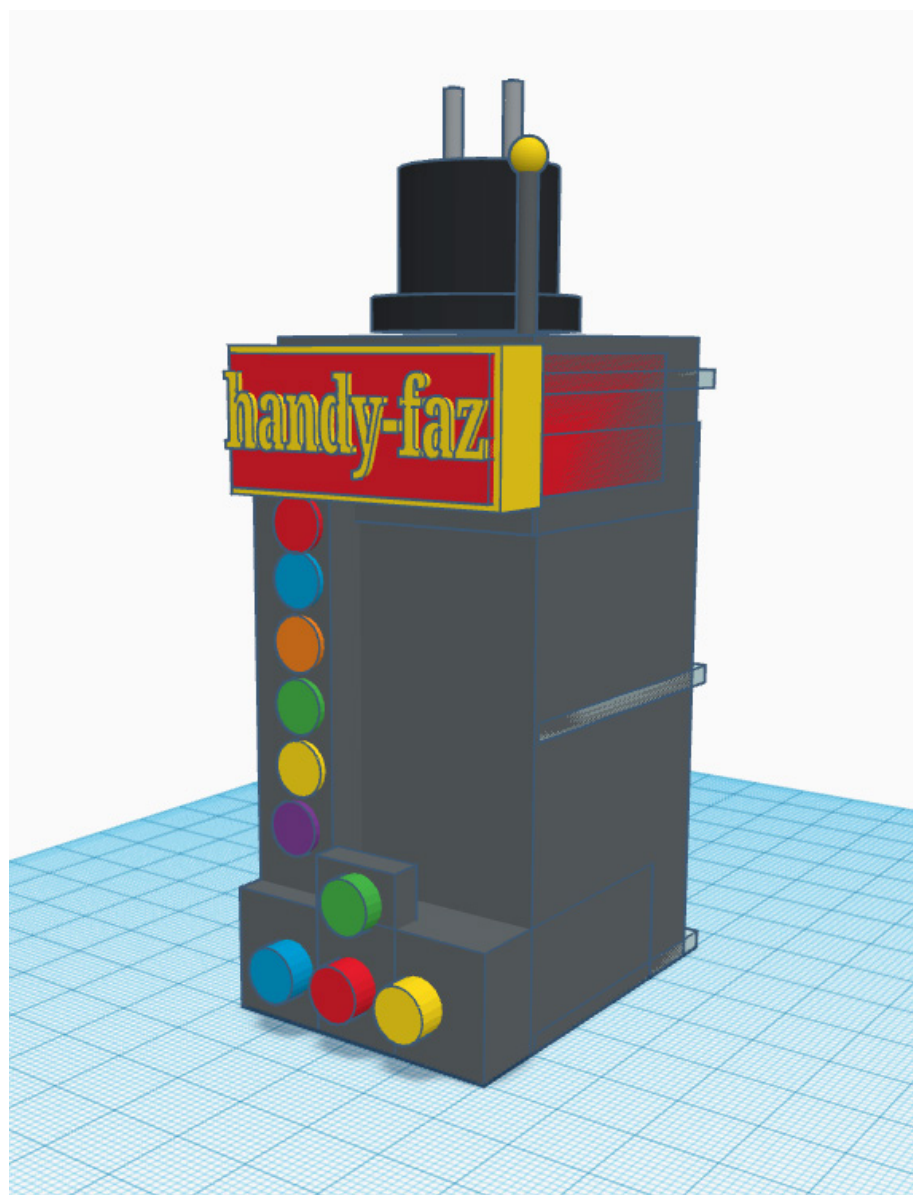

Artist Spotlight

Olivier D. • Colonel Crawford High School



Olivier D. is a 10th-grade student at Colonel Crawford High School. They love to watch movies and TV shows. They also love to draw and read as well.

Their favorite part of LEVEL UP is all the opportunities teens have as part of the program. They especially like the opportunities to create digital art and 3-D designs and printing.

In the future, they would like to become a tattoo artist and a designer.

they say that, from space,
the Earth looks like
a small, blue ball. i'll throw it
for you, laika, if you'll chase it









Max! ☺



Artist Spotlight

Cami S. • Homeschool



Cami S. is a 7th-grade student who is homeschooled. She loves reading and drawing.

Her favorite part of LEVEL UP is having the opportunity to meet people, and she loves that she's been able to learn to do a lot of cool stuff.

In the future, she would like to become a paramedic.

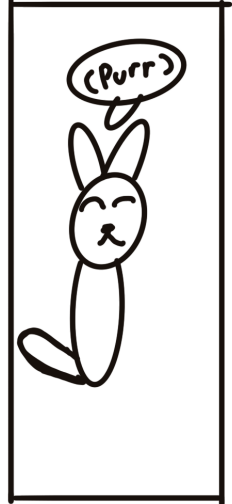
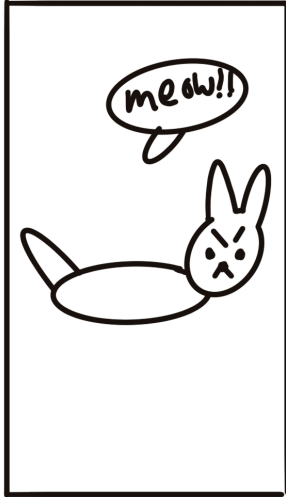





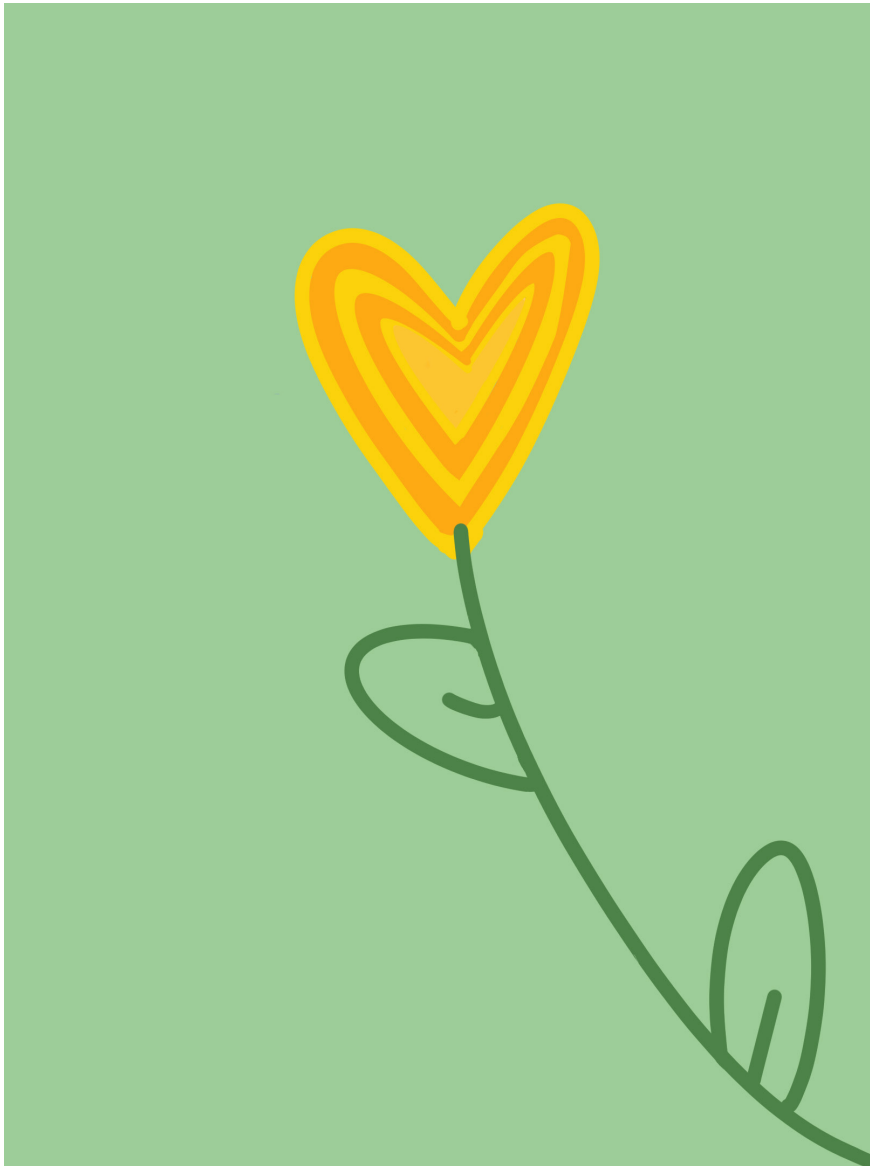

Artist Spotlight

Kaitlyn R. • Bucyrus Secondary School



Kaitlyn R. is a 10th-grade student at Bucyrus Secondary School. She loves to play tennis, do arts and crafts, read, and hang out with her friends.

Her favorite part of LEVEL UP is playing the library's new guitars and learning how to play songs.

In the future, she would like to become a cosmetologist and open her own salon one day.

The Adventures of Snoopdogg and Gdawg!



Kaitlyn



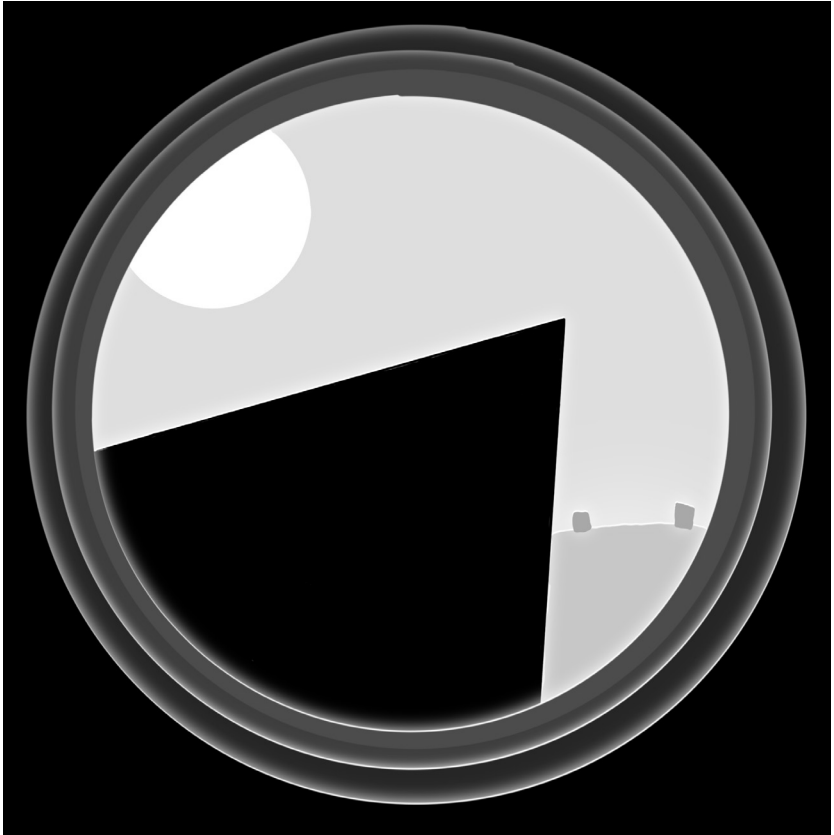



Mariya G.

Bucyrus Secondary School

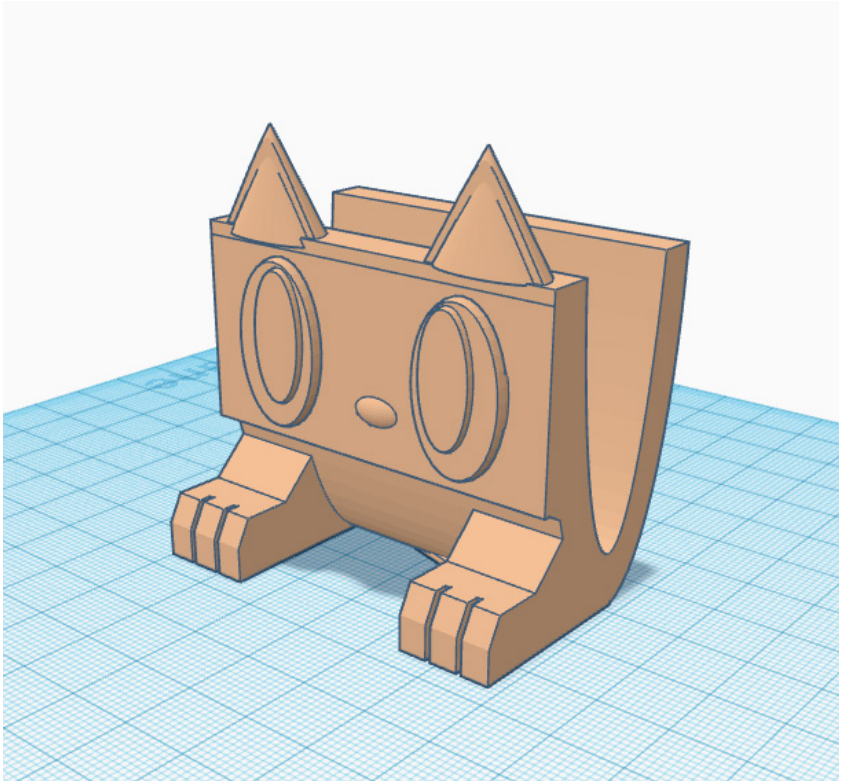





Cayden P.

Bucyrus Secondary School





Nyla H.

William Crawford Intermediate





DID SOMEBODY
SAY
SLAY!!!

Zach O.

Bucyrus Secondary School

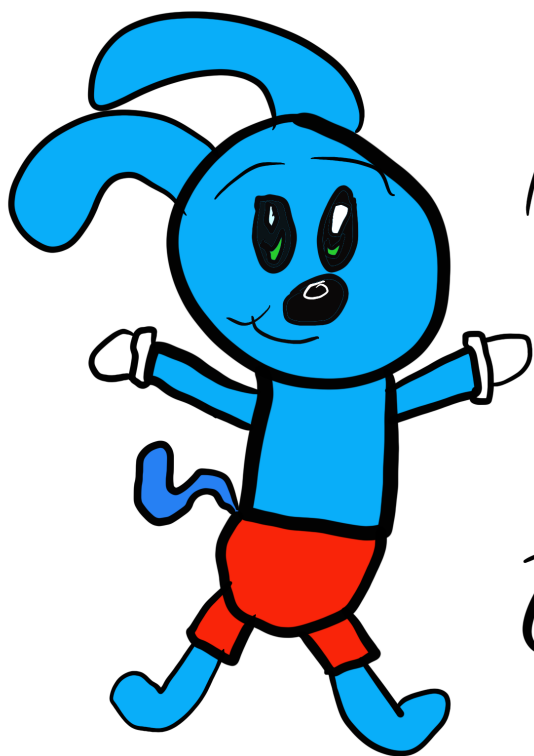

RIGGY
RUNKEY

Zach
O.



TAODAB SHORT

by Zach

I Love you Smile and write that

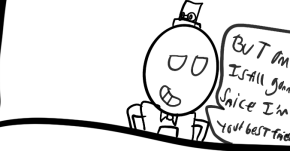

And they went to jail for...

DA

Brooklyn C.

Homeschool



Chance P.

Bucyrus Secondary School

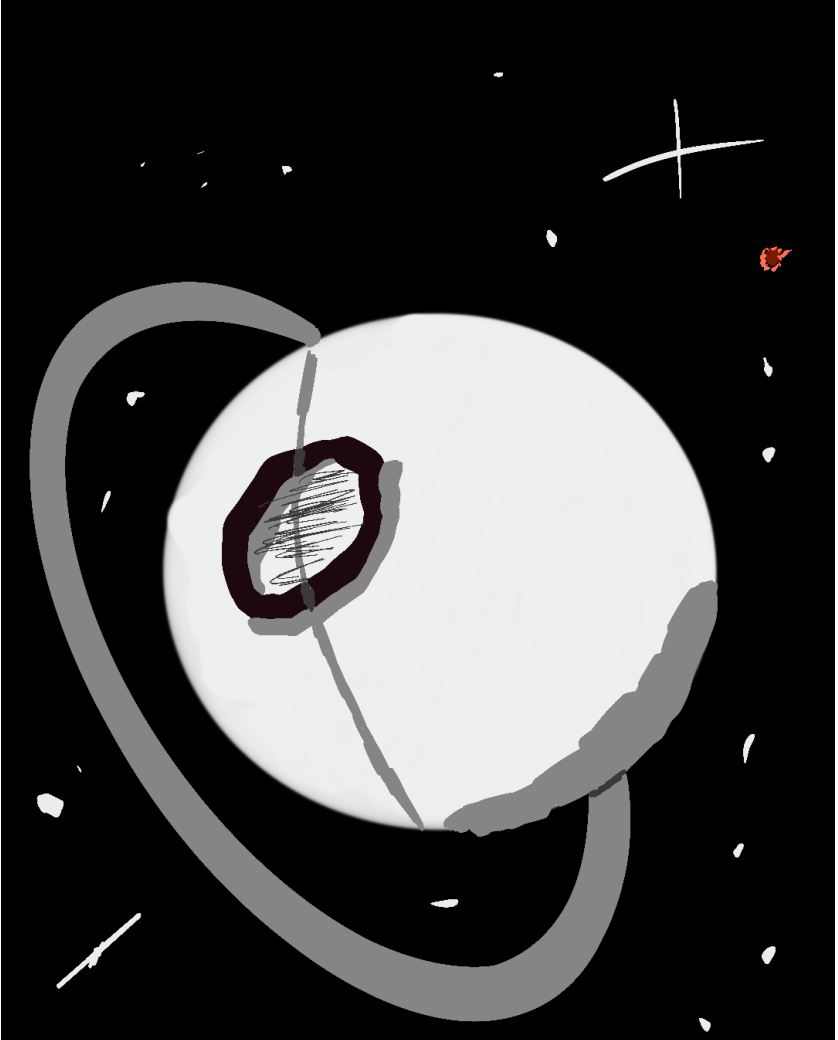

Kailey S.

Bucyrus Secondary School



Isabella S.

Bucyrus Secondary School



Aivlyn F.

Bucyrus Elementary School

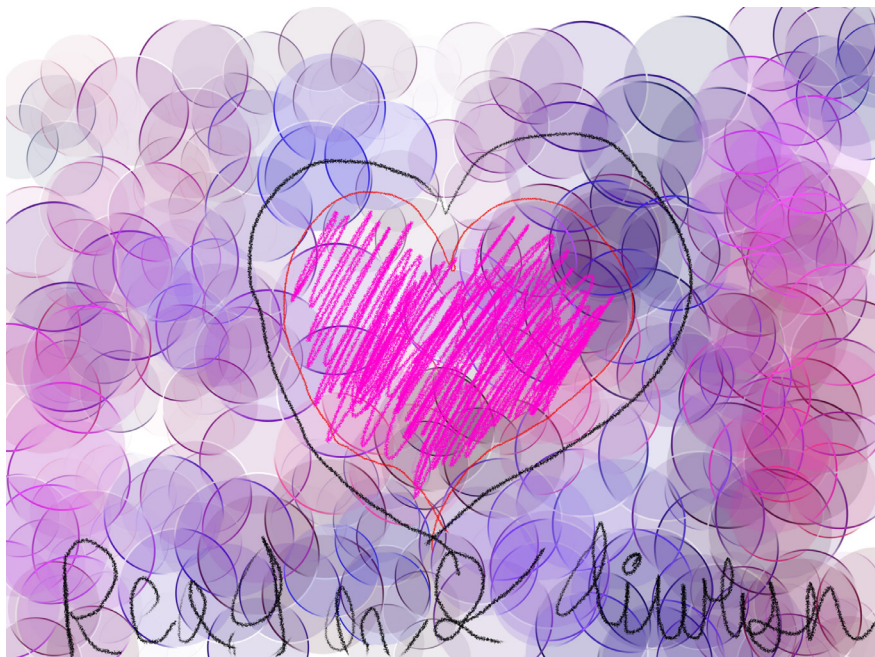

Angelica L.

Bucyrus Secondary School



James S.

"A Phone Stand"
William Crawford Intermediate

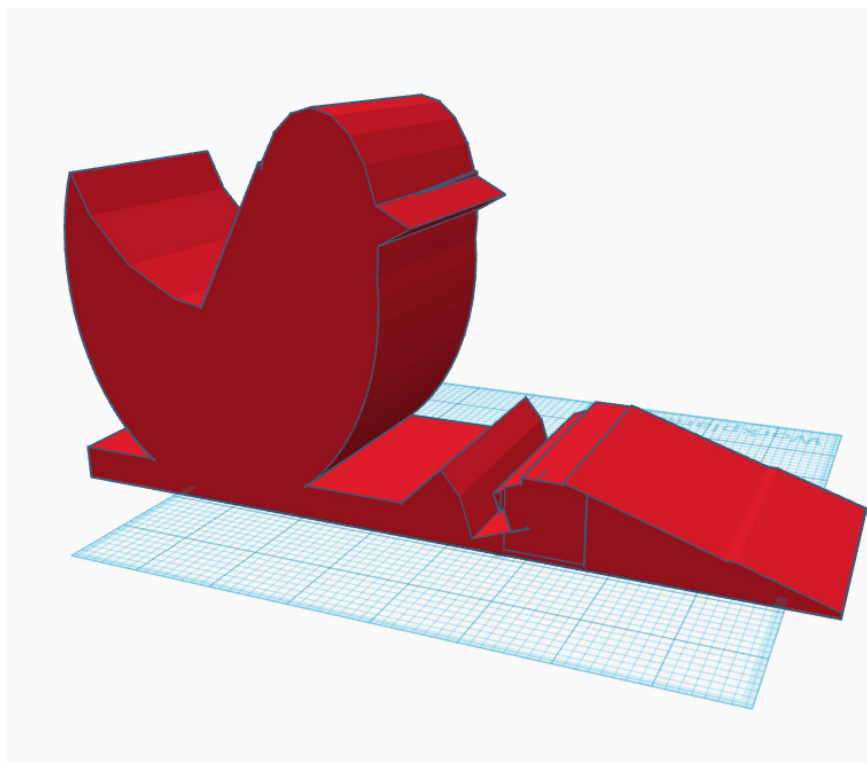

Emily S.

"A Phone Stand"
William Crawford Intermediate

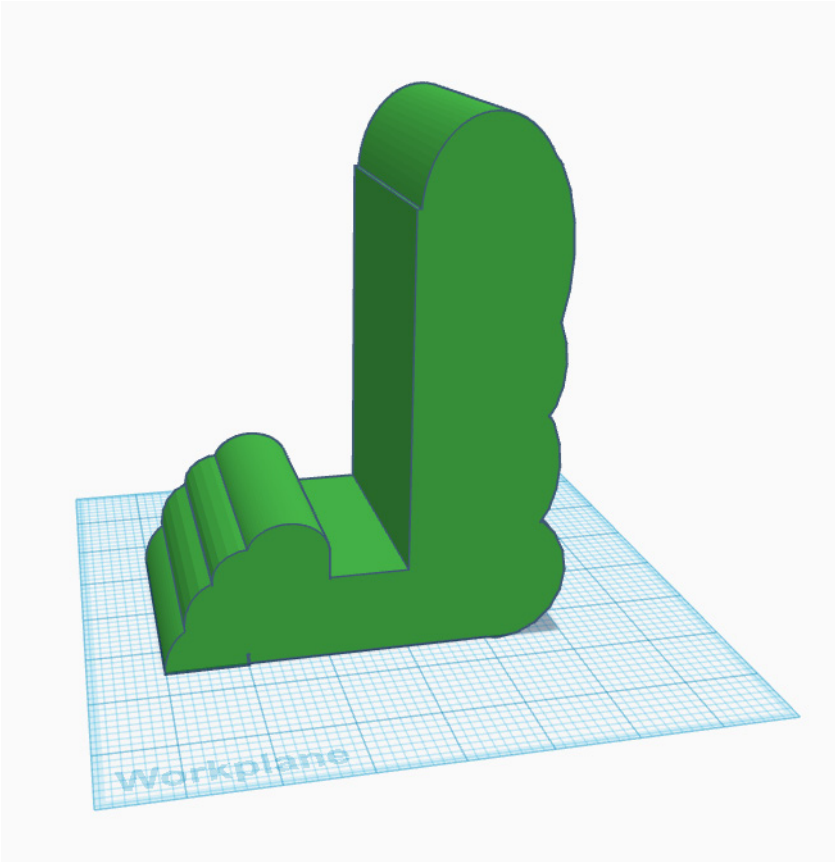

Cade F.

Wynford High School

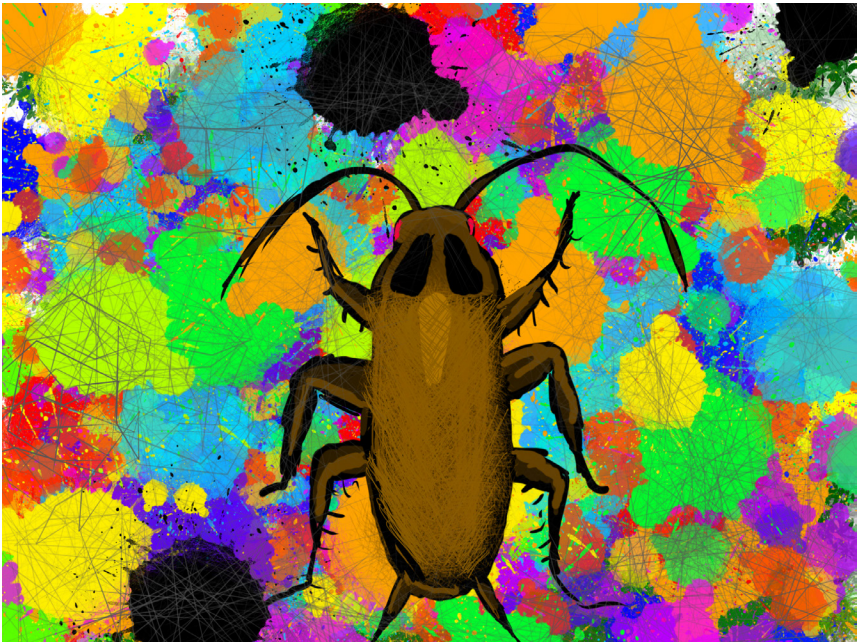

Izabella

Bucyrus Secondary School



Jade W.

Colonel Crawford High School

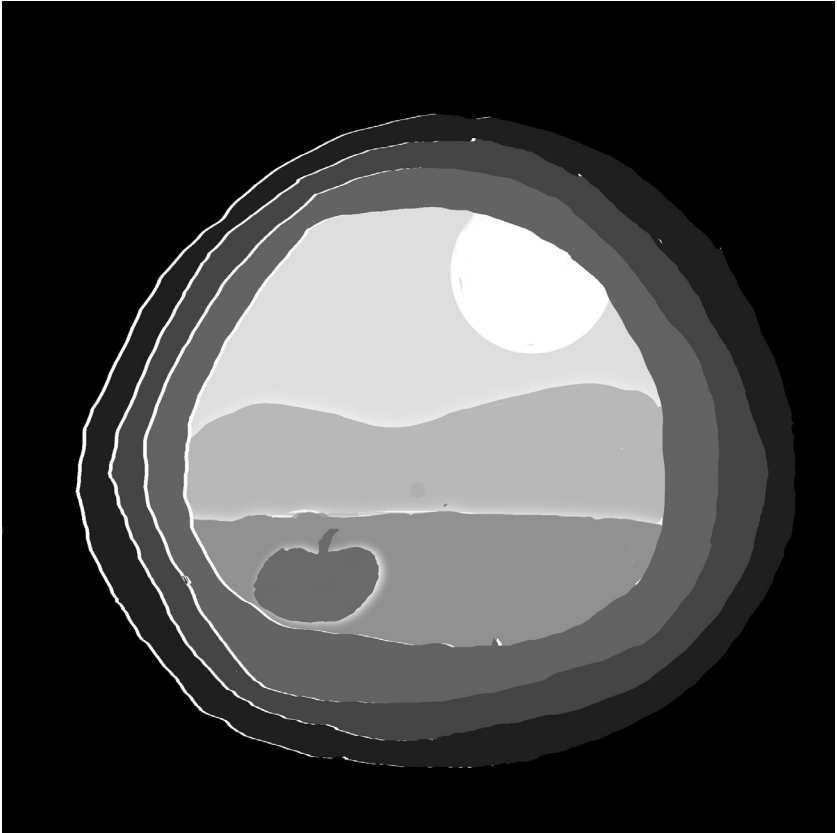

Alex B.

**"A Taco Stand"
Bucyrus Secondary School**

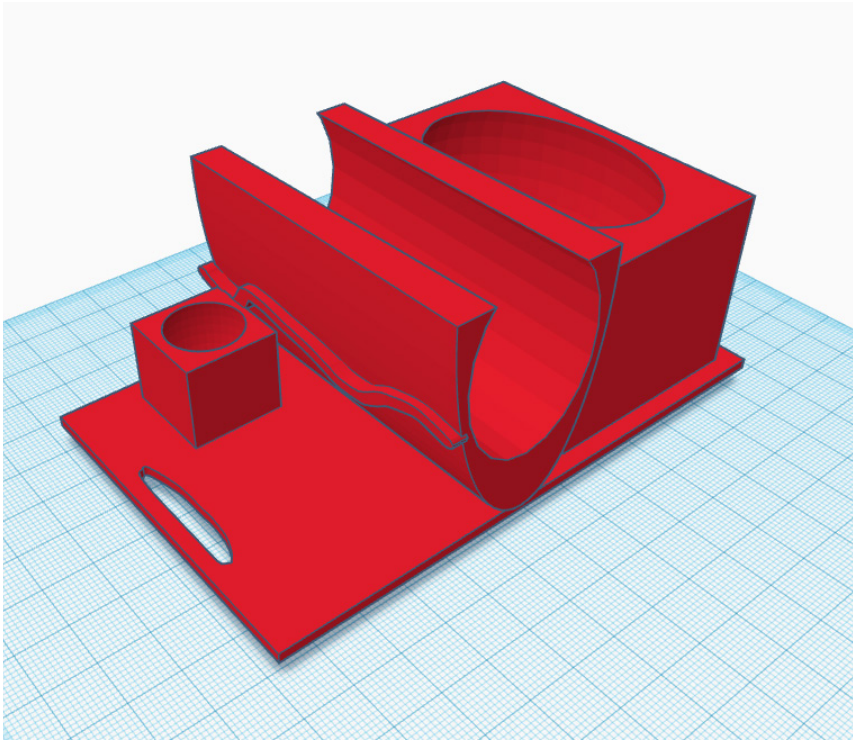

Lee L.

**"A Taco Stand"
Bucyrus Secondary School**

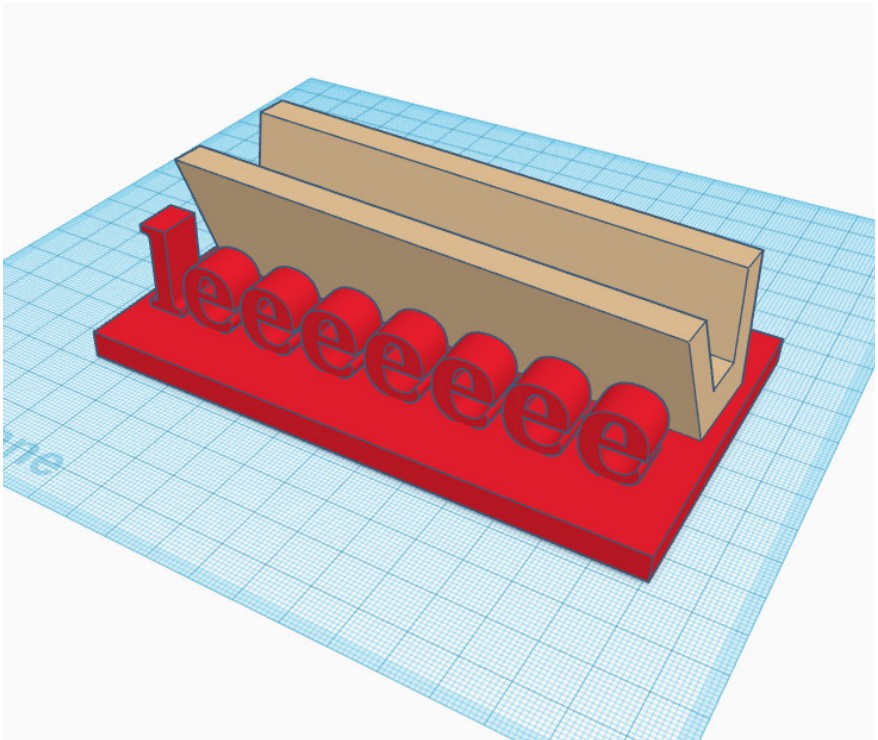

Jerald H.

Bucyrus Secondary School

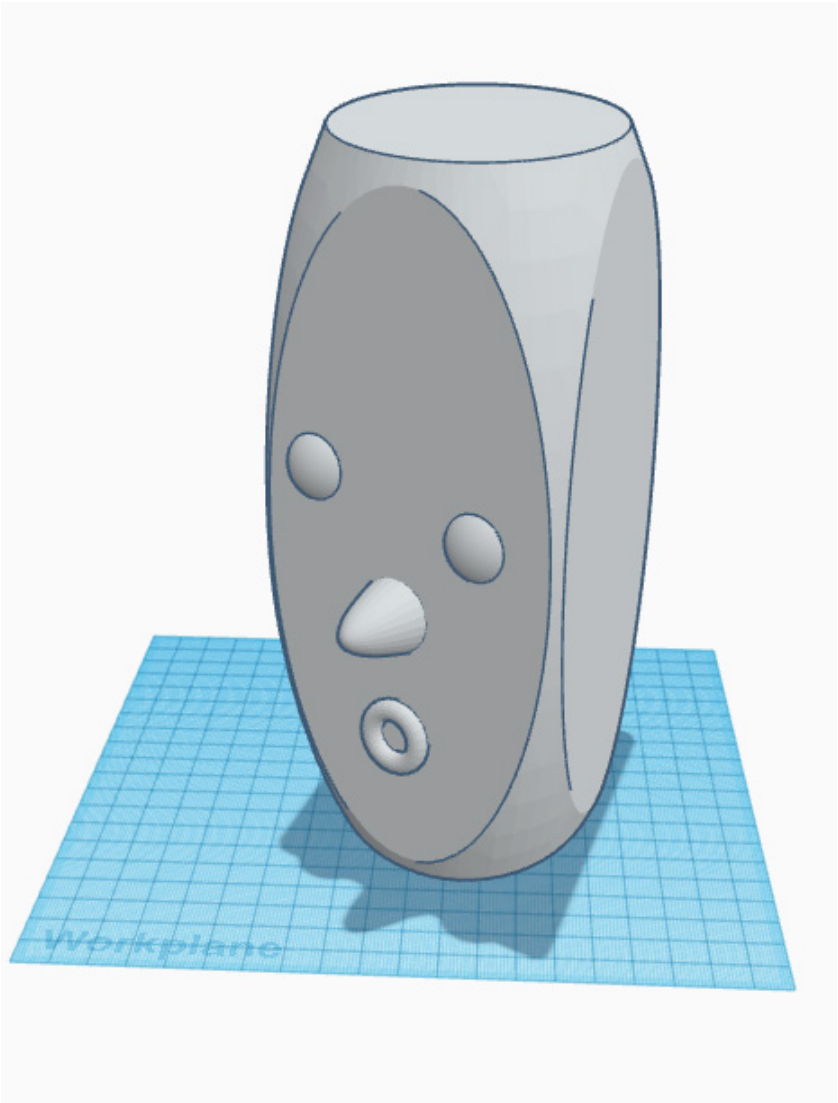

Domonic D.

High Roads School of Bucyrus

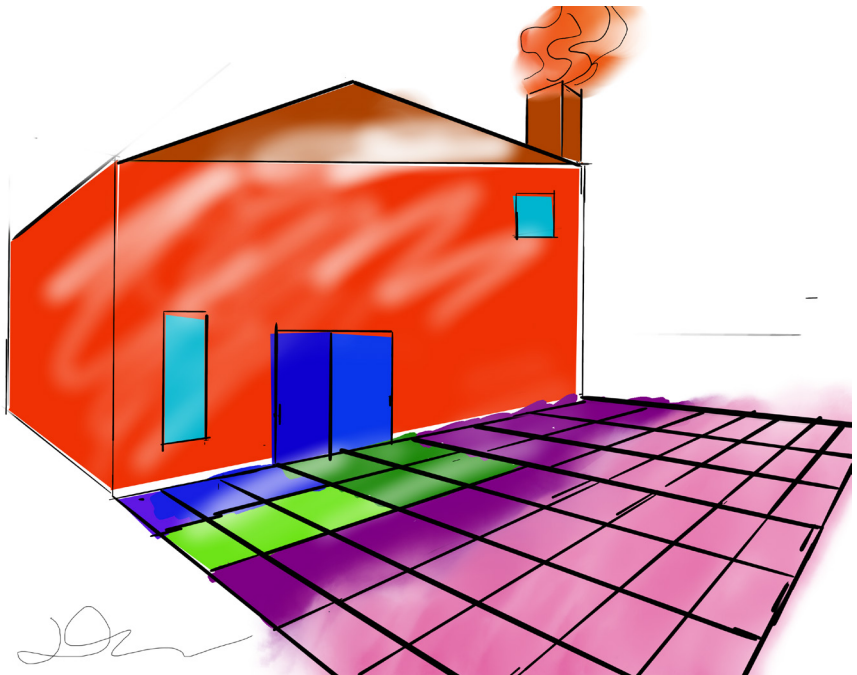

Riona R.

High Roads School of Bucyrus





BUCYRUS PUBLIC LIBRARY